

EXPERIMENTAL INVESTIGATION OF THE CRITICAL HEAT FLUX IN HORIZONTAL CHANNELS WITH CIRCUMFERENTIALLY VARIABLE HEATING

A. I. LEONTIEV, I. L. MOSTINSKY, V. S. POLONSKY,
M. A. STYRIKOVICH and I. M. CHERNIKA

Institute for High Temperatures of the U.S.S.R. Academy of Sciences, Moscow, U.S.S.R.

(Received 26 June 1980)

Abstract—The paper presents the outcome of the tests on the critical heat fluxes in horizontal round tubes with circumferentially uniform and variable heating. The experiments were run on small stainless steel 6 mm I.D. tubes at pressures of $p = 6.86; 9.81; 13.73$ MPa, mass flow rates $\rho w = 750, 1000, 2000$ kg m⁻² s⁻¹ and critical steam qualities $x_{cr} = -0.5-0.7$. The degree of nonuniformity in the circumferential heat flux distribution amounted to $q^{max}/\bar{q} = 1.50$. The local values of the maximum critical heat flux, q_{cr}^{max} , with nonuniform heating are shown to be somewhat higher than those of q_{cr} in uniformly heated channels. Yet, the averaged values of the critical heat flux \bar{q}_{cr} are much lower in the region of negative relative enthalpies and actually coincide with q_{cr} in the case of uniform heating at large positive steam qualities.

NOMENCLATURE

p ,	pressure [MPa];
ρw ,	mass flow rate [kg m ⁻² s ⁻¹];
q ,	heat flux [W m ⁻²];
r ,	latent heat of vaporization [J kg ⁻¹];
h ,	enthalpy [J kg ⁻¹];
ΔQ ,	heat losses [J s ⁻¹];
T ,	temperature [°C];
x ,	steam quality;
d ,	internal diameter [m];
D ,	external diameter [m];
l ,	length [m];
e ,	eccentricity [mm];
l/d ,	relative length;
F ,	cross-sectional area [m ²];
U ,	voltage [V];
J ,	current [A];
j ,	specific electrical resistance [Ω m];
μ ,	coefficient of heat spreading.

Superscripts

'	liquid phase;
*	initial;
-	sign of averaging;
max,	maximum;
ex,	external.

Subscripts

w,	wall;
in,	inlet;
cr,	critical;
wor,	working;
aux,	auxiliary;
tot,	total.

INTRODUCTION

THE PROCESS of boiling, and the burnout phenomenon

in particular, claim the attention of many scientists. A keen interest in this research is associated, first of all, with a rapid advance in a number of areas of new technology. To design reliable apparatus, knowledge about the upper limit of the admissible heat fluxes is indispensable. However, with all this voluminous experimental information accumulated on the burnout heat transfer, its systematization is extremely difficult because of a lack of a phenomenological theory of the process.

The majority of studies of the critical heat fluxes have been carried out in vertical steam-generating channels with a symmetric flow structure. On the other hand, a horizontal tube panel is now a familiar arrangement used in the practice of designing equipment for atomic power stations and other power engineering applications. Such channels develop some specific features that may affect the conditions for the boiling crisis occurrence. These comprise the possibility of flow lamination and circumferentially variable heating.

In vapour-liquid flow through horizontal channels, the gravity effect can, under certain conditions, promote separation of phases with a resulting lower critical heat flux as compared to vertical circular tubes. It is only at high coolant velocities that the values of q_{cr} coincide. With circumferentially variable heating the generatrix with the maximum heat evolution and elevated steam quality turns out to be in the most unfavourable conditions of heat transfer.

Earlier works [1-6] devoted to the study of critical heat fluxes of water and steam-water flows in vertical tubes with circumferentially variable heating have shown that the law of heating affects the value of q_{cr} . The boiling crisis is shown to take place at a high value of the heat flux; the curves $q_{cr} = q(x)$ and $q_{cr}^{max} = q(\bar{x})$ obtained with uniform and nonuniform heating are almost equidistant [1, 2]. At the same time, Remizov

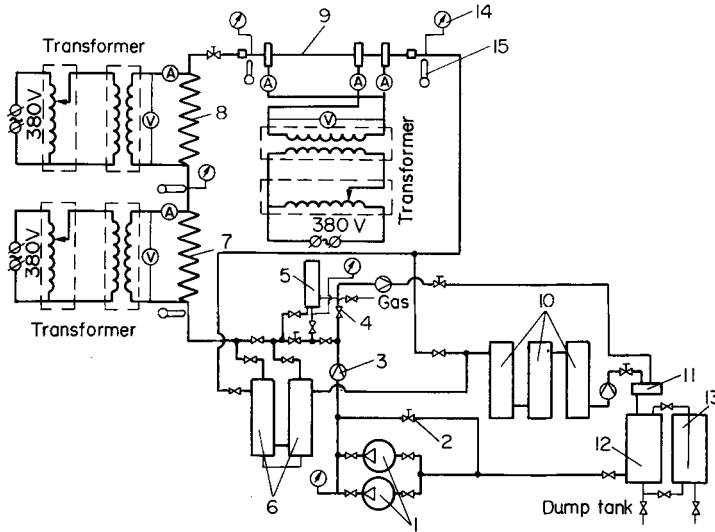

FIG. 1. Schematic diagram of the experimental set-up: 1 circulation pumps; 2 control valve; 3 disc flowmeter; 4 cut-off valve; 5 damper; 6 regenerative heat exchangers; 7, 8 electric heaters; 9 test section; 10 coolers; 11 sampling vessel; 12 dump tank; 13 supply tank; 14 manometer; 15 submerged thermocouple.

and Sapankevich [6] noted that with high subcooling the maximum values of the critical heat flux q_{cr}^{max} show a tendency to coincide with the values for uniform heating. As to the averaged values of the critical heat flux, \bar{q}_{cr} , at negative relative enthalpies, these are lower than similar values in the case of uniform heating. As the steam quality changes over from a negative to a positive one, the average critical heat fluxes approach the corresponding values typical of uniform heating.

The objective of the present research was to study the effect of nonuniformity in the circumferential heat flux distribution on the critical heat flux in horizontal channels. The unfavourable combination of the heat flux maximum and elevated steam quality at the upper generatrix can induce a premature boiling crisis and damage to the confining walls.

EXPERIMENTAL FACILITY—TEST SECTION

Investigation of the critical heat fluxes in a horizontal tube heated nonuniformly around its perimeter was carried out on a setup which is a closed circulation loop (Fig. 1). Circulation of the coolant was effected by feed water pumps. From a supply tank the coolant is fed into the loop where it passes in succession through preheaters, a test section, heat exchangers and then is discharged to a dump tank. To reduce flow fluctuations, a damper, partially filled with argon, is installed in the loop ahead of the preheaters and a throttling valve upstream of the test section. The coolant was a chemically demineralized water.

Working elements of the preheaters and the test section were heated by passing an alternating low-voltage current. The power was varied by means of one-phase voltage regulators connected in series to

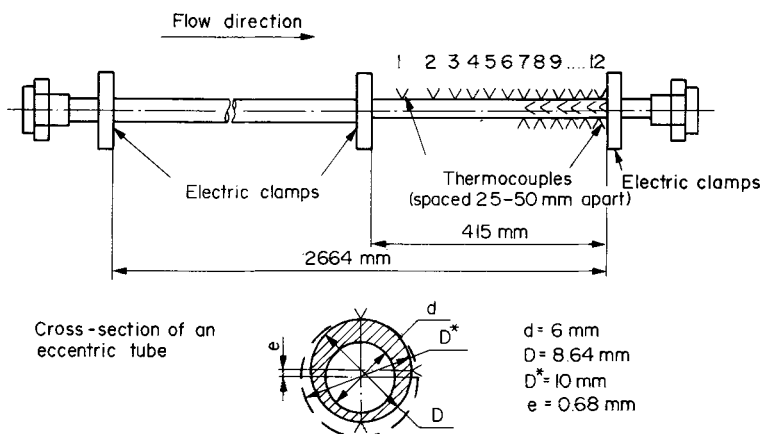

FIG. 2. Schematic of a test section.

one-phase transformers.

The test section, composed of a working and auxiliary segments, was placed horizontally so that the zone of maximum heating would lie on the upper generatrix (Fig. 2). The working portion of the test section was made of an eccentric tube, while the auxiliary part, of a concentric tube of the same internal diameter. Three copper clamps were welded to the test section, with the current being fed through flexible copper bars. The onset of the crisis was detected from a change in the temperature behaviour of the upper generatrix.

Nonuniform circumferential distribution of the heat flux over the working portion was achieved by passing the current of different density around the tube perimeter. A stainless steel tube of a standard design with diameter of 10×2 mm was specially outlined by machining on a lathe, with the tube rotation axis being displaced relative to the internal generatrix axis. The eccentricity amounted to 0.68 mm, the external and internal diameters were 8.64 and 6 mm, respectively. The heated length of the working section amounted to 415 mm. Heating of such a tube provided nonuniform heat generation over the perimeter and almost uniform one along its length.

The temperature of the outer surface of the test section was controlled by 24 chromel-copel thermocouples 0.5 mm dia. Taking into account a peculiar nature of the burnout occurrence in horizontal channels, the tube wall temperature of the working section was measured on the upper, lateral and lower generatrices of the tube. The thermocouples were spaced 25–50 mm apart.

The last three thermocouples that control the temperature of the upper generatrix at the outlet from the test section were connected to separate potentiometers (class of accuracy ± 0.25) which automatically disengaged loading as soon as the temperature was 600°C . The leads of the remaining thermocouples, both submerged and welded to the surface, were brought out to potentiometers too. The temperature of the coolant upstream and downstream of the electric heater (7) at the inlet to, and outlet from, the test section was measured by submerged chromel-copel thermocouples (0.5 mm dia.).

The pressure at different points in the loop and over the test section was measured by standard manometers (class of accuracy 0.4). The coolant flow rate was measured downstream of coolers (10) by a disc flowmeter and registered on a recorder (class of accuracy 1.6). The electric power supplied to the working and auxiliary sections was measured by a current transformer with the aid of ammeters and a voltmeter of the electrodynamic systems (class of accuracy 0.5).

EXPERIMENTAL PROCEDURE AND TREATMENT OF DATA

All tests were conducted at several separate pressures 6.86, 9.81, 13.73 MPa, mass flow rates 750, 1000, $2000 \text{ kg m}^{-2} \text{ s}^{-1}$ and mean values of the critical steam

quality from -0.5 to 0.7 . In the majority of experiments the crisis was attained at constant enthalpy, pressure and velocity by means of smooth increase in the electric power of the working section. At a pressure of $p = 9.81$ MPa and flow rate $\rho w = 2000 \text{ kg m}^{-2} \text{ s}^{-1}$ the boiling crisis was attained following the law $q = \text{constant}$ at the expense of increase in the flow enthalpy at the inlet into the test channel.

The local values of the maximum critical heat flux $q_{\text{cr}}^{\text{max}}$ were determined for the last cross-section of the channel with a normal temperature from the power supplied at the time of the boiling crisis occurrence on the upper generatrix (following the recommendations of Belyakov *et al.* and Alferov *et al.* [7, 8]). The magnitude of the coefficient of heat spreading over the tube perimeter was taken into account according to Alferov *et al.* [8]. The boiling heat transfer coefficient was calculated for the case of uniform heating [9].

Mean mass steam quality of the flow at the location of the burnout was determined from

$$\bar{x}_{\text{cr}} = \frac{h_{\text{in}} - h'}{r} + \frac{4(\bar{q}_{\text{cr}} l_{\text{cr}} + q_{\text{aux}} l_{\text{aux}})}{r \rho w d} \quad (1)$$

where

$$\bar{q}_{\text{cr}} = \frac{U J_{\text{wor}} - (\Delta Q)_{T_{\text{w, wor}}^{\text{ex}}}(l_{\text{wor}}/l_{\text{tot}})}{\pi d l_{\text{wor}}}$$

is the mean value of the critical heat flux related to the internal tube diameter;

$$q_{\text{aux}} = \frac{U J_{\text{aux}} - (\Delta Q)_{T_{\text{w, aux}}^{\text{ex}}}(l_{\text{aux}}/l_{\text{tot}})}{\pi d l_{\text{aux}}}$$

is the heat flux density in the auxiliary section.

The critical steam quality on the upper generatrix with maximum heating was calculated under the assumption of no flow mixing

$$x_{\text{cr}}^{\text{max}} = \bar{x}_{\text{cr}} + \frac{4(q_{\text{cr}}^{\text{max}} - \bar{q}_{\text{cr}}) l_{\text{cr}}}{r \rho w d} \quad (2)$$

where

$$q_{\text{cr}}^{\text{max}} = \mu \bar{q}_{\text{cr}} \frac{F_j^{\text{max}}}{\bar{F}_j^{\text{max}}}$$

is the maximum value of the critical heat flux related to the internal diameter [7].

ANALYSIS OF EXPERIMENTAL RESULTS

The experimental data were processed in the form of the parametric dependence of the mean and local maximum critical heat fluxes on the cross-section-averaged and maximum steam qualities at the location of the burnout at constant velocity and pressure. For local values of the maximum critical heat flux $q_{\text{cr}}^{\text{max}}$ the corresponding values of the steam quality were determined for the zone of the upper generatrix on the assumption that there is no flow mixing across the tube. The degree of nonuniformity in heat flux distribution (with due account for heat spreading) over the perimeter amounted to $q^{\text{max}}/\bar{q} = 1.50$.

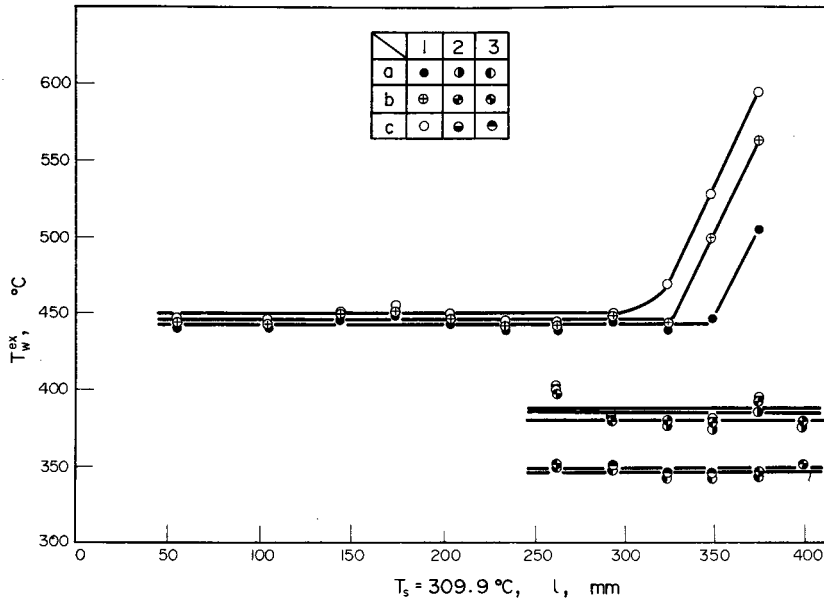

FIG. 3. Temperature conditions of a horizontal round tube nonuniformly heated over the perimeter at a pressure of $p = 9.86$ MPa and mass flow rate $\rho w = 2030 \text{ kg m}^{-2} \text{ s}^{-1}$: (a) $q_{cr}^{max} = 2.90 \text{ MW m}^{-2}$, $\bar{x}_{cr} = 0.255$; (b) $q_{cr}^{max} = 2.95 \text{ MW m}^{-2}$, $\bar{x}_{cr} = 0.250$; (c) $q_{cr}^{max} = 3.05 \text{ MW m}^{-2}$; $\bar{x}_{cr} = 0.240$; 1 upper generatrix; 2 lateral generatrix; 3 lower generatrix.

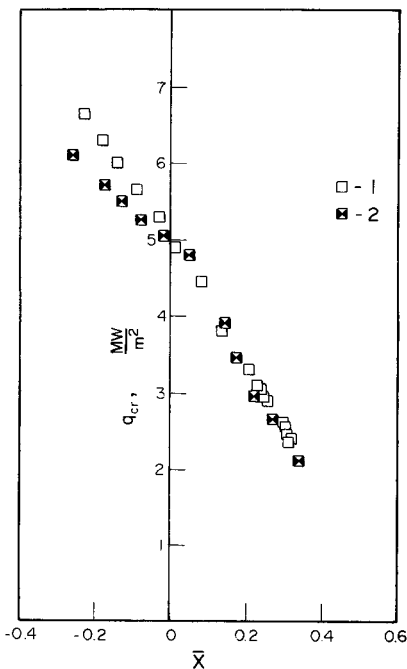

FIG. 4. Comparison of the maximum critical heat fluxes obtained in experiments carried out following different procedures at a pressure of $p = 9.81$ MPa and flow rate $\rho w \cong 2000 \text{ kg m}^{-2} \text{ s}^{-1}$: 1 $q = \text{var.}, h_{in} = \text{const.}$; 2 $q = \text{const.}, h_{in} = \text{var.}$

All of the tests were carried out in fluctuation-free conditions. The burnout was always observed on the upper generatrix at the end of the test section. As the heat loading was increased, the location of the crisis shifted upstream along the upper generatrix (Fig. 3). Under the conditions studied the wall temperature on the lateral and lower generatrices was virtually unaffected. Only at small critical heat fluxes and large positive steam qualities the boiling crisis started on the lateral and then on the lower generatrix of the tube.

As a rule, the burnout is studied at constant pressures and flow rates. But, as is known, the real processes accompanied by the boiling crisis take place during increase in the heat flux. Figure 4 shows the results of experiments carried out following different procedures: $q = \text{var.}, h_{in} = \text{const.}$ and $q = \text{const.}, h_{in} = \text{var.}$ A certain difference in the critical heat fluxes in the region of averaged negative relative enthalpies is due to somewhat different mass flow rates used in the tests. At $\bar{x}_{cr} < 0$ the tests, carried out following the first procedure, were run at $\rho w = 2100 \text{ kg m}^{-2} \text{ s}^{-1}$, while following the second procedure, at $\rho w = 1950 \text{ kg m}^{-2} \text{ s}^{-1}$. As a whole, the coincidence of the data on q_{cr} may be claimed as good.

The governing parameters of the burnout with forced motion of the coolant in the channel of a specified geometry are: pressure, mass flow rate, heat flux and steam quality in the burnout zone. The effect of nonuniform heating over the tube perimeter can be revealed from comparison with similar data obtained under standard conditions, i.e. in a uniformly heated smooth horizontal round tube (Fig. 5). The tests of this

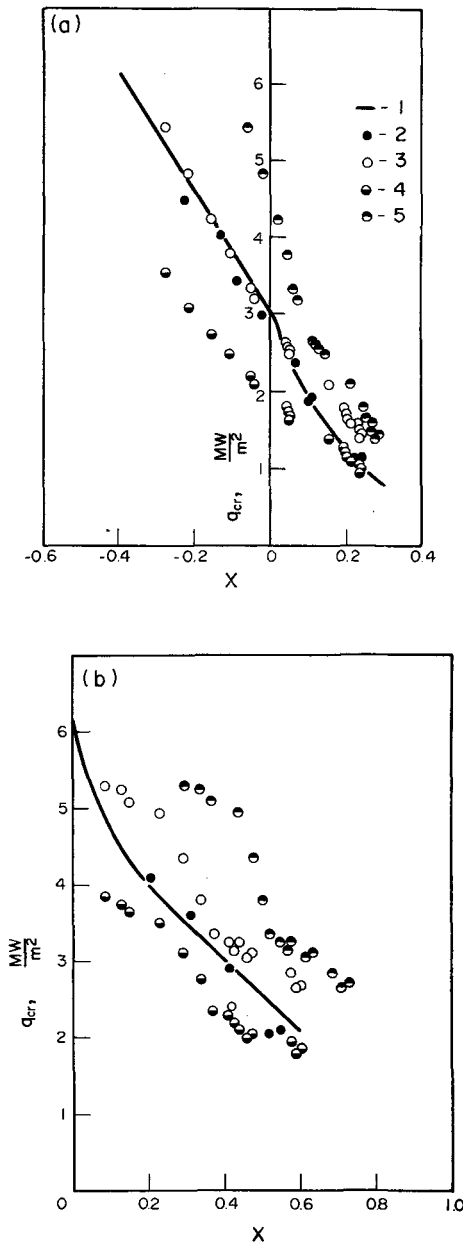

FIG. 5. Dependence of the critical heat flux on steam quality for circumferentially uniform and variable heating: (a) $p = 13.73$ MPa, $p_w = 2000$ kg m⁻² s⁻¹; (b) $p = 6.86$ MPa, $p_w = 1000$ kg m⁻² s⁻¹; 1 critical heat flux q_{cr} for uniformly heated vertical round tube [10]; 2 q_{cr} for uniformly heated horizontal tube; 3 local maximum critical heat flux q_{cr}^{max} at \bar{x}_{cr} ; 4 mean critical heat flux \bar{q}_{cr} at \bar{x}_{cr} ; 5 maximum critical heat flux q_{cr}^{max} at \bar{x}_{cr}^{max} .

series were conducted on a stainless steel tube, of diameter 10×2 mm, with the length of the working section equal to 450 and 910 mm. Unlike the experiments with nonuniform distribution of the heat flux, the experiments with uniform heating were conducted following the second procedure only ($q = \text{const.}$, $h_{in} = \text{var.}$). The experimental data are presented in Fig. 5

also in the form of a parametric dependence of the critical heat flux q_{cr} on the critical steam quality at constant velocity and pressure. Also shown are the data [10] recommended for a vertical 8 mm I.D. channel. An examination of the figures reveals that at the flow rates $\rho w = 1000$ and 2000 kg m⁻² s⁻¹ there is rather a good coincidence between the critical heat fluxes for uniformly heated horizontal and vertical round tubes.

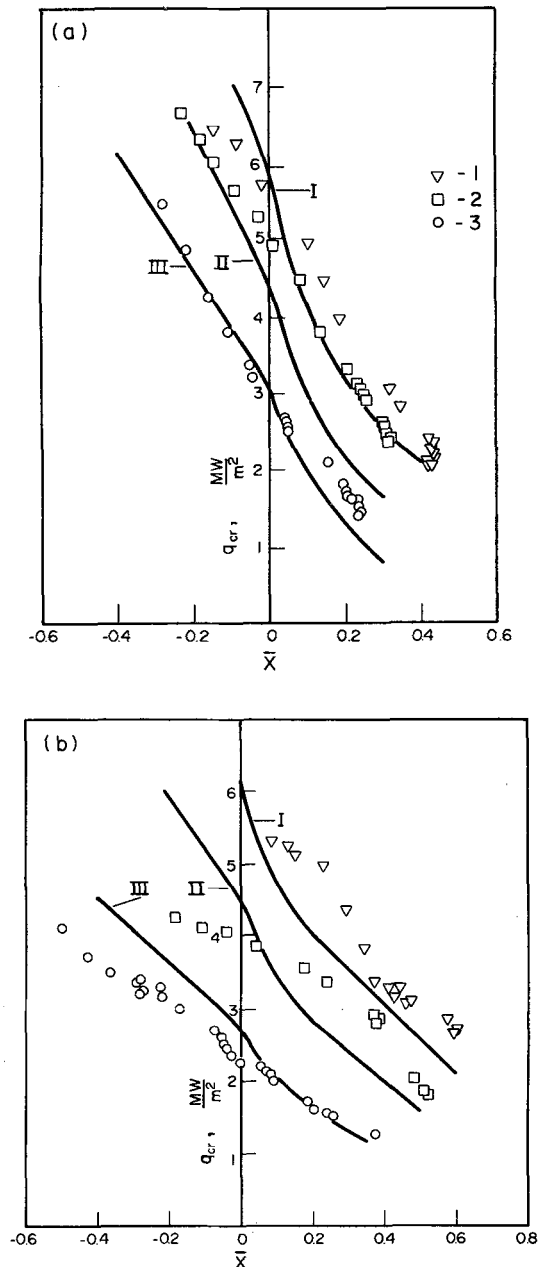

FIG. 6. Pressure effect on the dependence of the critical heat flux on steam quality: (a) $p_w = 2000$; (b) $p_w = 1000$ kg m⁻² s⁻¹; 1 $p = 6.86$; 2 $p = 9.81$; 3 $p = 13.73$ MPa—maximum critical heat flux q_{cr}^{max} for circumferentially variable heating; I $p = 6.86$; II $p = 9.81$; III $p = 13.73$ MPa— q_{cr} for uniformly heated vertical channel [10].

The analysis of the results on the critical heat fluxes obtained in nonuniformly heated horizontal channels has shown that in the main the boiling crisis obeys the same laws which hold for uniform distribution of the heat flux. Mean and maximum critical heat fluxes decrease monotonically with increase in the steam quality. However, there is a certain conspicuous difference caused by an asymmetric temperature field over the tube circumference.

Comparison between the local values of the maximum critical heat flux q_{cr}^{max} at \bar{x}_{cr} and the data on the critical heat flux q_{cr} for the case of uniform heating has shown that the curves for q_{cr}^{max} lie somewhat higher. On the other hand, the data on q_{cr}^{max} at x_{cr}^{max} lie much above the values of q_{cr} obtained at $x = x_{cr}^{max}$. The curves for the mean critical fluxes \bar{q}_{cr} for nonuniform distribution of the heat flux over the perimeter are more flat than similar curves for q_{cr} in the case of uniform distribution. In the region of negative averaged critical steam qualities the values of the mean critical heat flux lie below those for uniform heating. As the changeover from negative to positive averaged steam qualities occurs, the mean critical heat fluxes \bar{q}_{cr} at the burnout location approach the corresponding values of q_{cr} for symmetric heating. At the cross-section-averaged steam qualities $\bar{x}_{cr} \geq 0.2-0.4$ their coincidence is revealed, i.e. circumferentially variable heat flux distribution does not influence the value of the critical heat flux \bar{q}_{cr} .

The coincidence of the averaged values of the critical heat flux \bar{q}_{cr} in the region of high positive steam qualities and the local values of the maximum critical heat flux q_{cr}^{max} at high subcooling [6] with the data on the critical heat flux q_{cr} for the case of uniform heating is attributed to a dissimilar thermal and hydrodynamic state of the flow at different enthalpies. In the region of negative relative enthalpies, mixing in the flow turns out to be insufficient for temperature equilibration across the tube, while at positive steam qualities a more thorough mixing aids in smoothing the thermal and hydrodynamic asymmetry of the flow.

The effect of pressure and mass flow rate is shown in Figs. 6 and 7. The results are presented in the coordinates $q_{cr}^{max} - \bar{x}_{cr}$. These figures also show the tabulated data taken from [10] for vertical tubes with circumferentially uniform heating. The values of q_{cr}^{max} decrease with increase in p within the whole range of the pressures studied. Coincidence of the results of the present investigation with the tabulated data is somewhat better at the mass flow rate $\rho w = 2000 \text{ kg m}^{-2} \text{ s}^{-1}$ than at $\rho w = 1000 \text{ kg m}^{-2} \text{ s}^{-1}$.

It is seen from Fig. 7 that in the range of flow rates studied the critical heat fluxes increase with decreasing ρw . This tendency is observed in the region of positive steam qualities. In the region $x < 0$ the relation $q_{cr}^{max} = q(\bar{x})$, by analogy with $q_{cr} = q(x)$ for uniform heating, seems to be different. Thus, the effect of pressure, flow rate and steam quality on the burnout for circumferentially nonuniform and uniform distribution of heat fluxes is qualitatively the same.

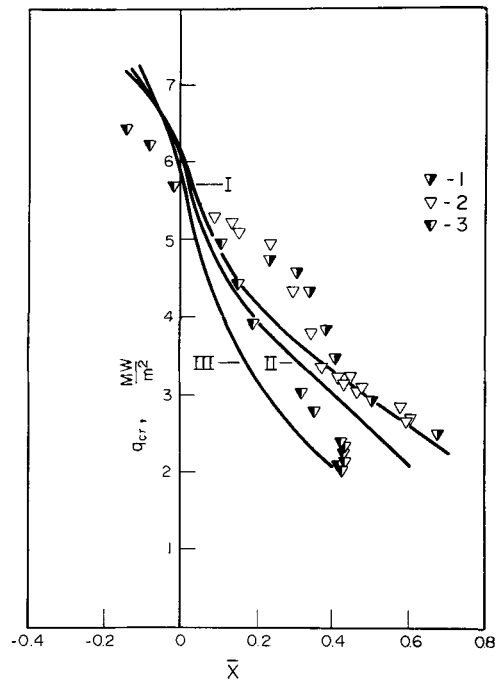

FIG. 7. Effect of the mass flow rate on the critical heat fluxes at $p = 6.86 \text{ MPa}$; 1 $\rho w = 750$; 2 $\rho w = 1000$; 3 $\rho w = 2000 \text{ kg m}^{-2} \text{ s}^{-1}$ – maximum critical heat fluxes q_{cr}^{max} in nonuniformly heated horizontal tube; I $\rho w = 750$; II $\rho w = 1000$; III $\rho w = 2000 \text{ kg m}^{-2} \text{ s}^{-1}$ – q_{cr} in uniformly heated vertical tube [10].

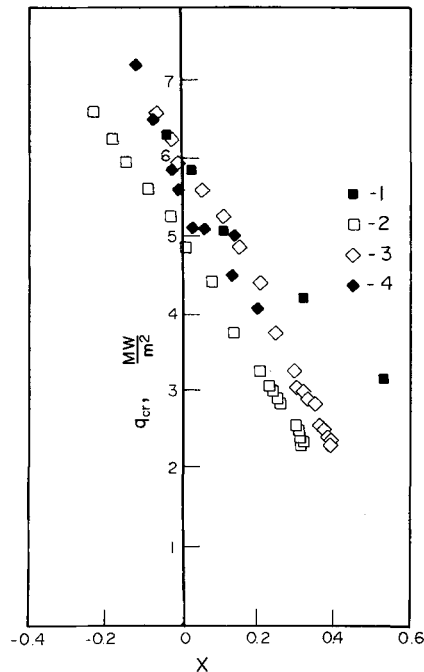

FIG. 8. Comparison of the critical heat fluxes with circumferentially variable heating for horizontal and vertical channels at $p = 9.81 \text{ MPa}$ and $\rho w = 2000 \text{ kg m}^{-2} \text{ s}^{-1}$. 1 $q_{cr}^{max} = q(\bar{x}_{cr})$ at $q_{cr}^{max}/\bar{q} = 1.64$ [2]; 2 $q_{cr}^{max} = q(\bar{x}_{cr})$; 3 $q_{cr}^{max} = q(\bar{x}_{cr}^{max})$ – data of the present work; 4 $q_{cr}^{max} = q(\bar{x}_{cr}^{max})$ at $q_{cr}^{max}/\bar{q} = 1.50$ [6].

At the same time, the law of heating over the perimeter substantially affects the quantitative relationships governing the process. Figure 8 compares the data of the present work with those reported by other authors [2, 6]. It is seen from this figure that in the case of about the same law of heating over the perimeter the data coincide rather fairly [6]. The results somewhat differ [2] when there are no identical heating over the perimeter and the length l/d . In engineering practice one encounters diversified circumferential distributions of the heat flux. It is reasonable to expect that the experimental verification of the whole variety of heating laws is extremely difficult. The development of the theory of the process is required which will make it possible to confine the research to separate experimental studies.

REFERENCES

1. M. A. Styrikovich and I. L. Mostinsky, On the effect of nonuniform heating of the tube perimeter on the value of the critical heat fluxes, *Dokl. Akad. Nauk SSSR* **127**(2), 316–319 (1959).
2. I. L. Mostinsky, Effect of the inlet conditions on the boiling crisis occurrence in nonuniform heating of the tube perimeter, *J. Engng Phys.* **3**(10), 5–10 (1960).
3. G. V. Alekseev, O. V. Remizov, N. D. Sergeev, B. A. Zenkevich, O. L. Peskov and V. I. Subbotin, Critical heat fluxes in forced water flow, *Teploenergetika* **3**, 47–51 (1965).
4. A. P. Ornatsky and L. S. Vinyarsky, Burnout heat transfer under the conditions of forced flow of subcooled water in small diameter tubes, *Teplofiz. Vysok. Temp.* **3**(3), 444–451 (1965).
5. B. Chojnowski and P. W. Wilson, Critical heat flux for large diameter steam generating tubes with circumferentially variable and uniform heating, *Heat Transfer – 1974 (Proc. of the Fifth International Heat Transfer Conference, 3–7 September 1974, Tokyo)*, vol. IV, pp. 260–264, Japan Society of Mechanical Engineers, Tokyo (1974).
6. O. V. Remizov and A. P. Sapankevich, Burnout heat transfer with circumferentially variable heat flux distribution over a round tube, *Teploenergetika* **12**, 70–74 (1975).
7. I. I. Belyakov, V. V. Sokolov and A. N. Kuznetsov, Heat transfer deterioration in a vertical uplift tube with circumferentially variable heating, *Energomashinostr.* **5**, 37–39 (1978).
8. N. S. Alferov, R. A. Rybin, B. S. Fokin, B. F. Balunov, E. N. Goldberg and A. E. Tisheninov, Experimental investigation of heat transfer to the supercritical water during uniform heating, *Energomashinostr.* **4**, 19–21 (1972).
9. V. A. Lokshin, D. F. Peterson and A. L. Shvarts (editors), *Hydraulic Calculation of Boiler Units (Normalized Method)*, Energiya, Moscow (1978).
10. *Recommendations on Calculation of the Burnout Heat Transfer in Water Boiling in Uniformly Heated Round Tubes* (Preprint 3-004), Institute of High Temperatures, Moscow (1975).

ETUDE EXPERIMENTALE SUR LE FLUX THERMIQUE CRITIQUE DANS LES
CANAUX HORIZONTAUX AVEC UN CHAUFFAGE VARIABLE SUR LA
CIRCONFERENCE

Résumé—On présente les conséquences des essais sur le flux critique thermique dans des tubes horizontaux à section circulaire avec un chauffage uniforme ou variable sur la circonférence. Les expériences sont conduites sur des petits tubes d'acier inoxydables de 6 mm de diamètre intérieur, à des pressions $p = 6,86; 9,81; 13; 73$ MPa, avec des débits $q_w = 750, 1000, 2000$ kg/m² s et des qualités de vapeur $x_{cr} = -0,5 - 0,7$. Le degré de variation du flux sur la circonférence atteint $q_{cr}^{max}/\bar{q} = 1,50$. Les valeurs locales du flux critique maximal q_{cr}^{max} avec un chauffage non uniforme sont sensiblement plus élevées que celles de q_{cr} dans le chauffage uniforme. Les valeurs moyennes du flux critique q_{cr} sont plus faibles dans la région des enthalpies relatives négatives et coïncident avec q_{cr} dans le cas du chauffage uniforme aux grandes qualités positives de vapeur.

EXPERIMENTELLE UNTERSUCHUNG ZUR KRITISCHEN
WÄRMESTROMDICHTEN IN HORIZONTALEREN ROHREN MIT
VARIABLER BEHEIZUNG AM UMFANG

Zusammenfassung—Es wird über die Ergebnisse von Versuchen zur kritischen Wärmestromdichte in horizontalen runden Rohren bei am Umfang gleichmäßiger und variabler Beheizung berichtet. Die Versuche wurden durchgeführt an kleinen Rohren aus rostfreiem Stahl mit 6 mm Innendurchmesser bei Drücken von $p = 6,86; 9,81$ und $13,73$ MPa, bei Massenströmen von $\rho w = 750; 1000$ und 2000 kg/(m²s) und kritischen Dampfgehalten von $x_{cr} = -0,5 \div 0,7$. Der Ungleichförmigkeitsgrad der Wärmestromverteilung am Umfang betrug bis zu $q_{cr}^{max}/\bar{q} = 1,50$. Die örtlichen Werte des größten kritischen Wärmestroms q_{cr}^{max} bei ungleichförmiger Beheizung ergeben sich etwas höher als die entsprechenden Werte bei gleichförmig beheizten Rohren. Dennoch sind die gemittelten Werte der kritischen Wärmestromdichte \bar{q}_{cr} im Gebiet negativer relativer Enthalpien sehr viel niedriger und fallen praktisch mit q_{cr} im Falle gleichförmiger Beheizung und großer positiver Dampfgehalte zusammen.

**ЭКСПЕРИМЕНТАЛЬНОЕ ИССЛЕДОВАНИЕ КРИЗИСА ТЕПЛОТДАЧИ
В ГОРИЗОНТАЛЬНЫХ КАНАЛАХ С НЕРАВНОМЕРНЫМ РАСПРЕДЕЛЕНИЕМ
ТЕПЛОВОГО ПОТОКА ПО ПЕРИМЕТРУ**

Аннотация — Приведены экспериментальные результаты по критическим тепловым потокам в горизонтальных круглых трубах с равномерным и неравномерным тепловыделением по периметру. Опыты проводились на трубках из нержавеющей стали внутренним диаметром 6 мм при давлениях $p = 6,86; 9,81; 13,73$ МПа, массовых скоростях потока $\rho w = 750, 1000, 2000$ кг/(м² с) и критических паросодержаниях $x_{кр} = -0,5 - 0,7$. Степень неравномерности распределения теплового потока по окружности составляла $q^{макс}/\bar{q} = 1,50$. Показано, что локальные значения максимального критического теплового потока $q_{кр}^{макс}$ при неравномерном обогреве несколько выше, чем $q_{кр}$ в равномерно обогреваемых каналах. В то же время осредненные значения критического теплового потока $\bar{q}_{кр}$ существенно ниже в области отрицательных энтальпий и практически совпадают с $q_{кр}$ для случая равномерного тепловыделения при больших положительных паросодержаниях.